

# DUAL VISOR SPH-5 HELMET ASSEMBLY

## Fitting, Operation, and Maintenance Instructions

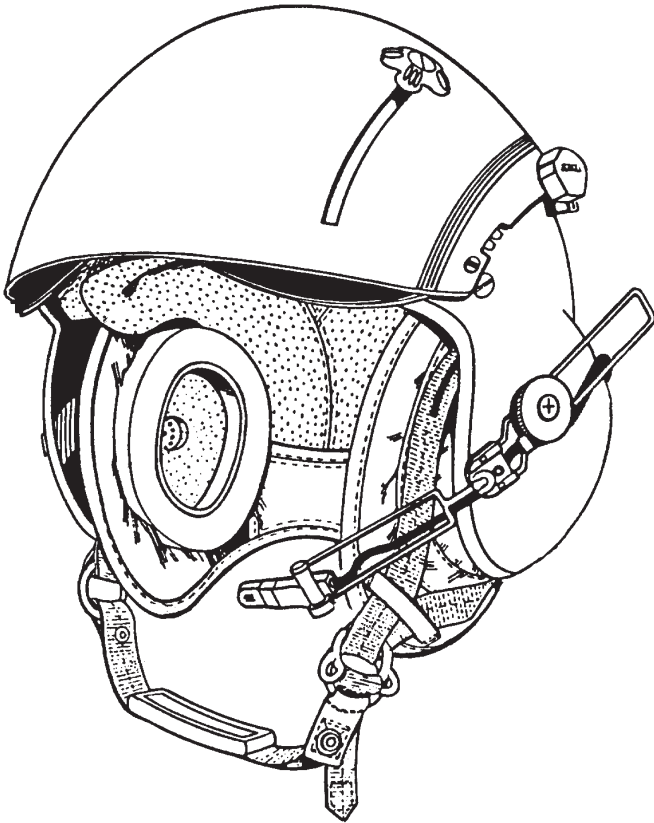

# CONTENTS

INTRODUCTION AND GENERAL DESCRIPTION . . . . .	1
HELMET SIZING . . . . .	2
HELMET FITTING AND OPERATION . . . . .	3
INSPECTIONS . . . . .	12
CLEANING . . . . .	14
REPLACEMENT PROCEDURE 1: ENERGY-ABSORBING LINER AND TPL . . . . .	14
REPLACEMENT PROCEDURE 2: RETENTION ASSEMBLY . . . . .	15
REPLACEMENT PROCEDURE 3: EARCUPS AND EARPHONES . . . . .	16
REPLACEMENT PROCEDURE 4: MICROPHONE ASSEMBLY . . . . .	18
REPLACEMENT PROCEDURE 5: COMMUNICATIONS CORD . . . . .	19
REPLACEMENT PROCEDURE 6: DUAL VISOR ASSEMBLY . . . . .	21
ILLUSTRATED PARTS BREAKDOWN . . . . .	24
OTHER VISOR STYLES AVAILABLE . . . . .	26

# INTRODUCTION AND GENERAL DESCRIPTION

This booklet provides operation and maintenance instructions, as well as an illustrated parts breakdown (IPB) on page 24, for the GENTEX® SPH-5® Helmet Assembly (Figure 1).

The SPH-5 is a lightweight helmet assembly providing head protection, noise reduction, and communication enhancement for helicopter personnel. It consists of an impact-resistant helmet shell, a polystyrene energy-absorbing liner, a preformed thermoplastic liner (TPL®) that allows for custom-fitting, a yoke-style retention assembly (including a chinstrap and a nape strap — both adjustable), sound-attenuating earmuffs, a dual visor assembly, and a communications assembly featuring a boom-mounted microphone and dual earphones. The helmet is available in four sizes: small, regular, X-large, and XX-large. (Other visor assembly styles are available and are listed at the end of this booklet. Contact Gentex Corporation for more information.)

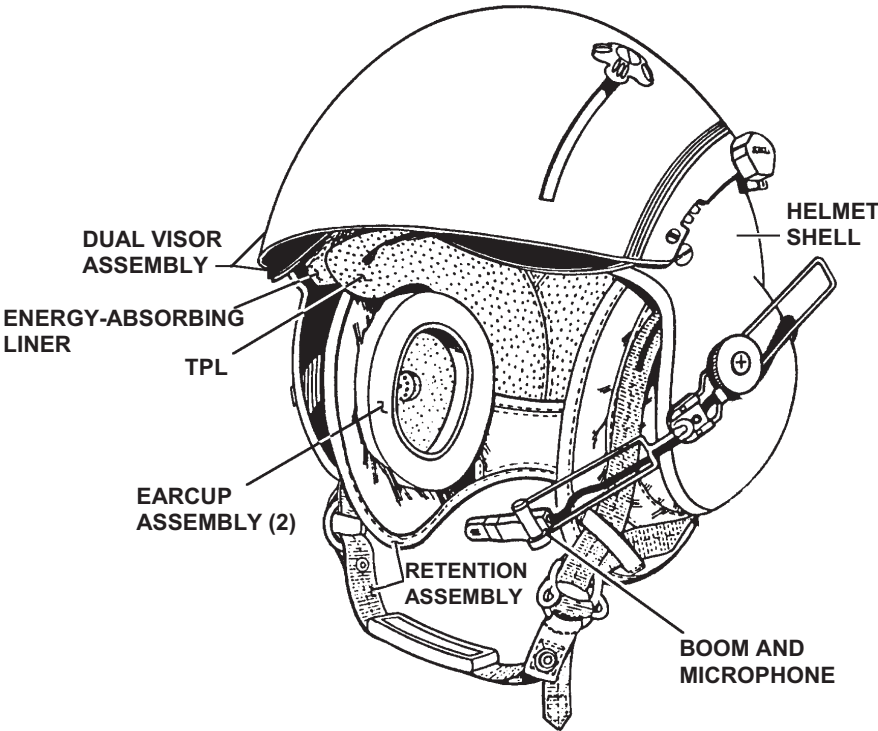

Figure 1. SPH-5 Helmet Assembly

GENTEX®, SPH-5®, and TPL® are registered trademarks of GENTEX Corporation.

**HELMET SIZING**

Helmet sizing is based on head circumference. (Figure 2 shows how the crewmember's head is measured for circumference.) Below are sizing parameters.

<b>HELMET SIZE</b>	<b>MAXIMUM HEAD CIRCUMFERENCE (INCHES)*</b>
Small	< 21.5
Regular	21.5 - 22.4
X-Large	22.4 - 23.5
XX-Large	> 23.5

- These are rule-of-thumb measurements. At times, the next larger or smaller size may be required to achieve a satisfactory fit.

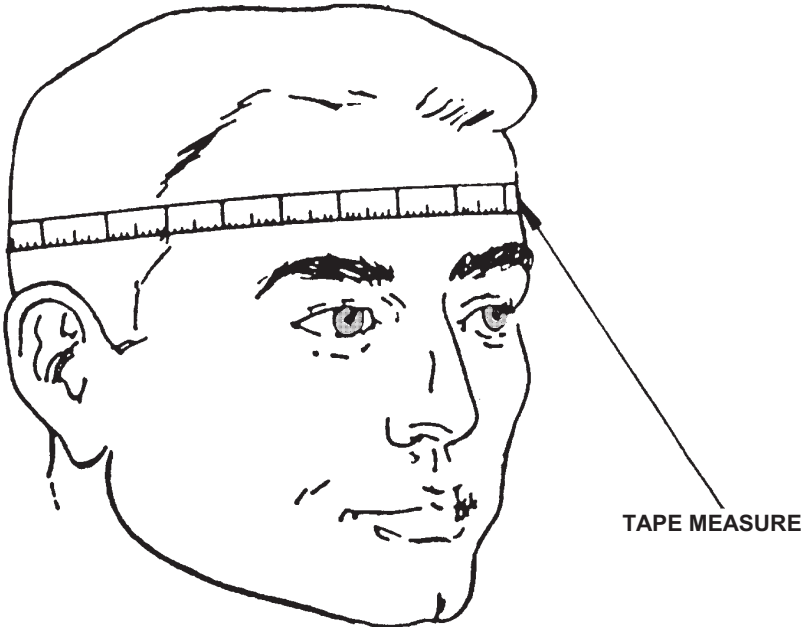

**Figure 2. Head Circumference for Helmet Sizing**

## HELMET FITTING AND OPERATION

In this procedure, you will ensure that the helmet is properly fitted to the crewmember. You will also familiarize the crewmember with operation procedures, including donning and doffing the helmet (Steps 1 and 8 respectively), adjusting the nape strap (Step 2), fastening and unfastening the chinstrap (Steps 3 and 7 respectively), operating the visors (Step 4), and operating the communications system (Step 5).

1. Have the crewmember don the helmet as follows:

### CAUTION

Spread the helmet slightly – just enough to allow ease of donning. Excessive spreading may damage the helmet.

- a. Grip the retention assembly below the earcups as shown in **Figure 3, view A**.
- b. Spread the sides of the helmet slightly and position the front edge firmly against the forehead as shown in **Figure 3, view B**.
- c. Roll the helmet back and down onto the head. Press the helmet firmly downward with both hands to ensure that the helmet is properly seated on the head and the ears are surrounded by the earcups. (The earcups can be rotated for optimum fit.)
- d. Check the distance between the eyebrows and the edge of the helmet shell; it should be approximately (but no more than)  $3/4$ " for optimum field of view.

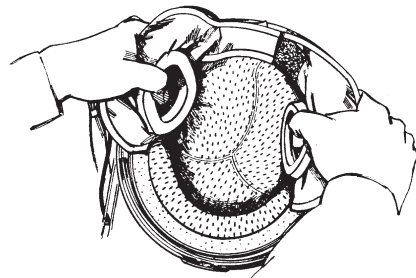

**A**

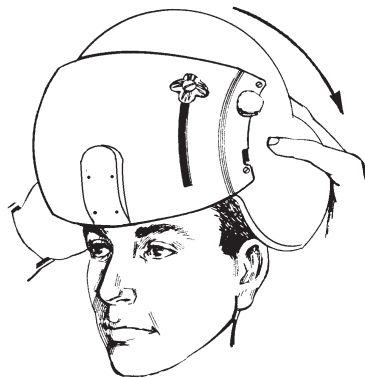

**B**

*(Continued on next page)*

**Figure 3. Donning Helmet**

## **WARNING**

For helmet stability, always tighten the nape strap and the chinstrap as snugly as possible when wearing the helmet. Failure to do so may result in injury.

2. Have the crewmember tighten the rear of the retention assembly by adjusting the hook-and-pile closure and tightening the nape strap through the adjustment buckle. (See **Figure 4.**)

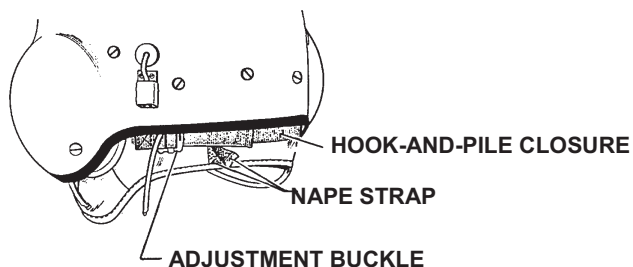

**Figure 4. Rear of Retention Assembly**

3. Have the crewmember fasten the chinstrap as follows:
  - a. If not already done, insert the snap end of the chinstrap through the D-ring on the right side (as worn) of the retention assembly and fasten the snap as shown in **Figure 5**, view **A**.
  - b. Feed the other end of the chinstrap through the D-rings on the left side of the helmet.
  - c. Split the D-rings, loop the chin strap end back through inner D-ring, and pull the chin strap through both D-rings as shown in **Figure 5**, view **B**.
  - d. Tighten the chinstrap to the desired tension. Once the desired tension is achieved, the chinstrap can be fastened and unfastened via the snap.



**Figure 5. Fastening and Adjusting Chinstrap**

4. Have the crewmember lower and raise the visors as follows (to test operation and clearance):

**NOTE**

Visor knobs can be moved to either side of the visor housing depending on crewmember preference. See Page 23 for instructions.

*Inner Visor*

- a. Unlock the visor by pushing the actuator knob downward as shown in **Figure 6**, view **A**.
- b. While holding the knob down, raise or lower the visor by sliding the knob along the track.
- c. Release the actuator knob in any of the visor lock positions.

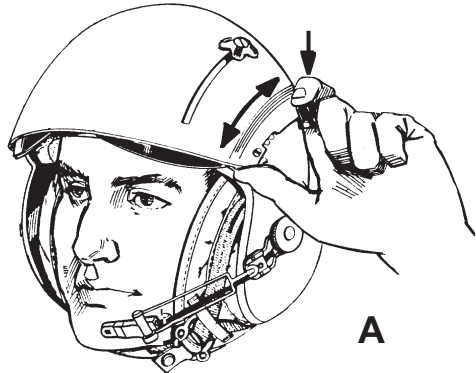

*Outer Visor*

- a. Unlock the outer visor by turning the center lock knob counterclockwise as shown in **Figure 6**, view **B**.
- b. Rotate the visor by sliding the knob along the housing slot.
- c. Lock the visor by turning the knob clockwise.

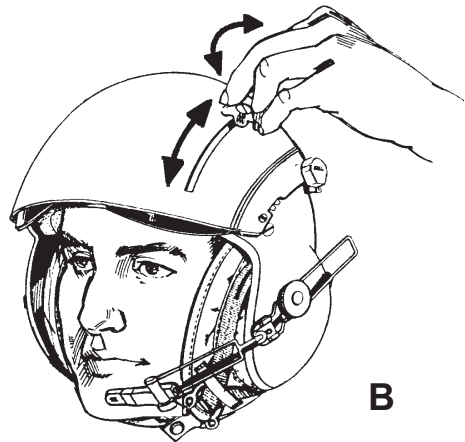

**Figure 6. Raising and Lowering Visors**

*(Continued on next page)*

## **CAUTION**

In Step 5, be sure to loosen the knurled nut on the swivel assembly before you rotate the boom assembly. Any attempt to rotate the boom assembly without loosening the knurled nut can cause the mounting hole in the helmet shell to become rounded; consequently, the boom assembly will not be held in place.

5. Referring to **Figure 7**, have the operator operate and adjust the communications system as follows:
  - a. Loosen the boom swivel assembly by rotating the knurled nut counterclockwise until the boom is free to move.
  - b. Rotate the boom up or down as needed.
  - c. Slide the boom backward or forward as needed.
  - d. Tighten the swivel by rotating the knurled nut clockwise.
  - e. Adjust the front of the boom as needed.
  - f. Loosen the knurled screw on the microphone, and adjust the microphone as needed. Tighten the screw.

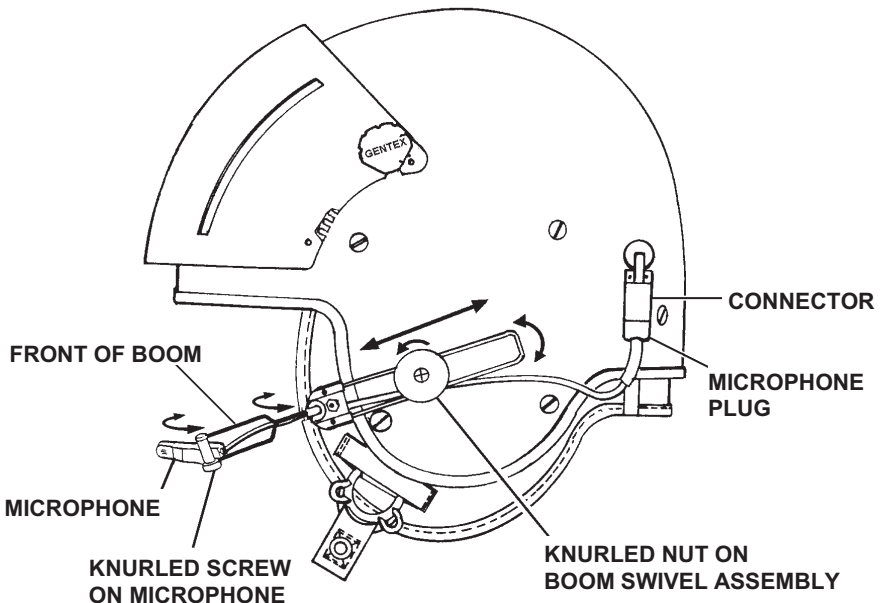

**Figure 7. Communications System Points of Operation**



6. Evaluate the fit according to the following criteria:
  - a. The earcups should surround the ears completely.
  - b. The earseals should be compressed to the greatest degree possible without discomfort.
  - c. The overall fit should be comfortable; no hot spots or pressure points should exist.

#### **NOTE**

After evaluating the fit, you will unfasten the chinstrap and doff the helmet as instructed in Steps 7 and 8. If the helmet fulfills all of the criteria listed in Step 6, mark and store the helmet as required. If the earcups do not surround the ears completely, refer to “Adjustment #1: Earcup Centering.” If the earseals are not sufficiently compressed, refer to “Adjustment #2: Earseal Compression.” If the overall fit is too tight or too loose, or hot spots or pressure points exist, refer to “Adjustment #3: TPL Custom-Fitting.”

7. Have the crewmember unfasten the chinstrap by unsnapping the strap and disengaging the strap through the right-hand (as worn) D-ring.
8. Have the crewmember doff the helmet as follows:

#### **CAUTION**

Spread the helmet slightly – just enough to allow ease of doffing. Excessive spreading may damage the helmet.

- a. Hook the thumbs in the earcups and spread the helmet at the earcup area.
- b. Roll the helmet upward and rearward as shown in **Figure 8**.

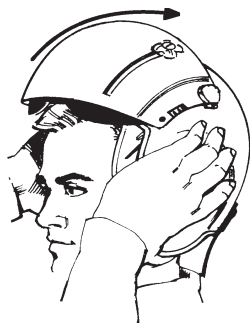

**Figure 8. Doffing Helmet**

## Adjustment #1: Earcup Centering

1. If the ears are not centered within the earcups, rotate the earcups within the retention assembly. Don the helmet, tighten the chinstrap, and recheck the earcup centering.
2. If the ears are not centered within the earcups after the earcups have been rotated, unfasten the chinstrap, doff the helmet, and remove the TPL as in Replacement Procedure 1, Step 1 (Page 13). Have the crewmember don the helmet and hold it so that the edge of the helmet is approximately 3/4" above the eyebrows. With the helmet in this position, check the location of the earcups. If the earcups now completely surround the ears, this indicates a need for TPL custom-fitting. Have the crewmember doff the helmet. Perform the TPL Custom Fitting Procedure. This should result in a proper fit of the helmet and the earcups.
3. If the ears are not centered in the earcups after the TPL has been removed, or you must raise or lower the helmet to achieve proper centering, you will have to adjust the retention straps upward or downward. To obtain access to these straps, you must remove the energy-absorbing liner and at least one earcup. Follow these steps:

- a. Remove either earcup from the retention assembly as in Replacement Procedure 3, Steps 2 and 3 (Page 16).
- b. Remove the energy-absorbing liner as in Replacement Procedure 1, Steps 3 and 4 (Page 14).

- c. Adjust the retention strap holes upward or downward as necessary. The front and center straps allow for upward or downward adjustment; the rear straps allow for forward or rearward adjustment. (See **Figure 9.**) Remove the attachment hardware. Apply one or two drops of white Weldwood glue #281 or equivalent to the first two threads of each screw and reinstall the hardware in the selected holes as needed.

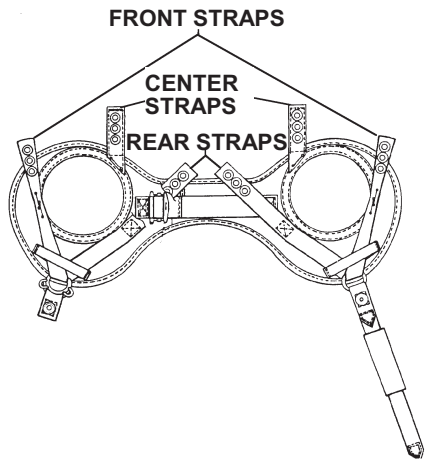

**Figure 9. Retention Straps**

- d. Reinstall the energy-absorbing liner as in Replacement Procedure 1, Step 5 (Page 14).
- e. Reinstall the earcups as in Replacement Procedure 3, Steps 10 -11 (Page 17).

- f. Reinstall the TPL as in Replacement Procedure 1, Step 7 (Page 14).
- g. Have the crewmember don the helmet and fasten the chinstrap. If the ears are now centered in the earcups, remove and store the helmet as required. If not, readjust the retention straps as necessary until the ears are centered in the earcups.

## Adjustment #2: Earcup Compression

1. If the earseals are not sufficiently compressed, doff the helmet and tighten the helmet cross straps. Two cross straps are located behind each earcup; each cross strap has a loop. To tighten each cross strap, insert a finger into the loop and move the loop toward the bottom of the shell. (See **Figure 10**.) Don the helmet, tighten the chinstrap, and recheck the earseal compression.

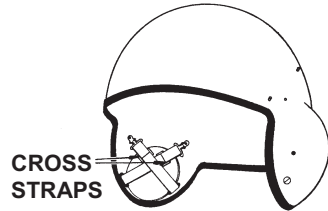

**Figure 10. Cross Straps**

2. If the earseals are not sufficiently compressed after the cross straps have been tightened, doff the helmet and add earcup spacer pads behind each earcup as required. The earcup spacer pad set supplied with each helmet consists of four pads (two 1/2" thick and two 1/4" thick) and pressure-sensitive pile fastener. Install the pads as follows:
  - a. Peel the backing from one pressure-sensitive pile fastener and apply the adhesive side of the fastener directly to the back of one earcup. Repeat for the other earcup.

### NOTE

Spacer pads may be installed whole or cut to any size or shape needed to increase or balance earcup compression. See **Figure 11** for examples.

*(Continued on next page)*



**Figure 11. Earcup Spacer Pad Uses**

- b. Attach spacer pad(s) to an earcup with the hook side of the pad facing the pile fastener on the earcup. Ensure that the fasteners are firmly attached. Repeat for the other earcup.
3. Don the helmet, tighten the chinstrap, and recheck the earseal compression. Add more spacer pads if needed until earseals are sufficiently compressed and a uniform, comfortable earcup fit is attained.

### **Adjustment #3: TPL Custom-Fitting**

If the helmet does not fit properly, i.e. it has hot spots or pressure points or the fit is too tight or too loose, remove the helmet and custom-fit the TPL following the Custom-Fitting Procedure below.

#### *Tools and Equipment Required*

1. Oven - Capable of stabilized sustained temperature of 200°F ± 5°F (93.3°C ± 2.8°C) with thermometer and internal volume of approximately 1.5 cubic feet or equivalent
2. Ruler
3. Timer or equivalent
4. Masking Tape

<b>STEP</b>	<b>RESULT/REMARKS</b>
1. Set oven rack to lowest position; heat oven to 200 F ± 5 F (93.3 C ± 2.8°C).	<ul style="list-style-type: none"> <li>- Ensure oven stabilizes at approximately 200°F.</li> <li>- Do not remove TPL cover; heat as a unit.</li> </ul>
2. Place TPL fabric side down in center of rack in heated oven.	<ul style="list-style-type: none"> <li>- Preview Steps 5 through 10 so that they may be completed within 30 seconds.</li> </ul>
<b><u>CAUTION</u></b>	
ENSURE THAT NO UPPER BURNER ACTIVATES DURING HEATING, OR TPL PLASTIC LAYERS WILL MELT.	
3. Allow oven to stabilize at temperature listed in Step 1 before starting timed sequence.	<ul style="list-style-type: none"> <li>- In helmet, cover hook fasteners on rear of energy-absorbing liner with masking tape to ease TPL positioning.</li> </ul>
4. Heat TPL for approximately 10 minutes.	<ul style="list-style-type: none"> <li>- Set timer, stopwatch, or equivalent.</li> <li>- Check TPL every two or three minutes to ensure plastic layers are not melting.</li> <li>- Describe procedure to crewmember being fitted.</li> </ul>
5. Remove TPL from oven.	<ul style="list-style-type: none"> <li>- Steps 5 - 10 should be completed within 30 seconds.</li> </ul>

STEP	RESULT/REMARKS
<p style="text-align: center;"><b><u>WARNING</u></b></p> <p>TPL PLASTIC WILL BE HOT TO TOUCH. AVOID BURNING HANDS. WEAR GLOVES IF NECESSARY.</p> <p>6. Squeezing sides of TPL together to clear earcups, place TPL in helmet with label and holes facing front.</p> <p>7. Align TPL to protrude approximately 1/4" past energy-absorbing liner.</p>	<ul style="list-style-type: none"> <li>- Ensure TPL is centered within the helmet.</li> <li>- Do not be concerned if rear of TPL extends beyond energy-absorbing liner.</li> </ul>
<p style="text-align: center;"><b><u>CAUTION</u></b></p> <p>HOT TPL PLASTIC LAYERS ARE SOFT. WHEN PERFORMING STEP 8, DO NOT PRESS TOO HARD IN ANY ONE AREA; THIS WILL DEFORM TPL.</p> <p>8. Position TPL crown into helmet.</p> <p>9. Have crewmember don helmet.</p> <p>10. With hands on top of helmet, press down until ears are centered in earcups. Hold for three to five minutes.</p>	<ul style="list-style-type: none"> <li>- To ensure TPL does not bunch up in rear during donning, hold rear of TPL against energy-absorbing liner while crewmember dons helmet. (See <b>Figure 12.</b>)</li> <li>- Ensure entire ear is surrounded by earcup; press helmet down further if necessary.</li> <li>- Chinstrap may be fastened to hold helmet in position.</li> <li>- Ensure helmet shell is centered comfortably on head.</li> <li>- Lower visors to check centering and nose clearance.</li> </ul>

*(Continued on next page)*

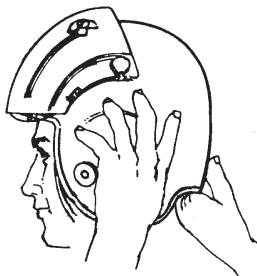

**Figure 12. Donning Helmet with Heated TPL**

STEP	RESULT/REMARKS
11. Check distance between eye-brow and edge of helmet shell.	- Distance should be approximately (but no more than) $\frac{3}{4}$ for optimum field of view.
12. Release pressure and remove helmet.	- Remove tape from hook fasteners covered in Step 3.
13. Have crewmember don helmet.	- Adjust earcups; tighten nape strap and chinstrap.
14. Check fit.	- Check for hot spots and pressure points. If none exist, remove and store helmet as required. If the helmet does not fit properly, remove TPL and repeat fitting procedure.
	<p style="text-align: center;"><b><u>WARNING</u></b></p> <p>In some cases, it will be necessary to remove one or more plastic layers to achieve an optimum fit. If removing layers, at least two layers must be retained or helmet stability will not be maintained. Do not remove outer layers; remove inner layers only. The TPL will not fit into the EA liner properly if outer layers are removed.</p>

### NOTE

The TPL cloth cover can be laundered or dry cleaned. Before removing cover in preparation for cleaning, note the direction in which the cover is facing. Note especially the “Y” seams on the cover; the double leg of the “Y” should face the front of the TPL and the single leg should face the rear. Replace the two-sided tape after cleaning, and install cover on layers in the proper direction.

**INSPECTIONS.** Inspections consist of preflight and postflight inspections by the user, and periodic inspections by the technician.

**Preflight Inspection.** Prior to each flight, the user should inspect the helmet assembly to see that it is in good working order. This inspection should ensure that:

1. The helmet, liners and earcup assemblies have been fitted properly.
2. The chinstrap and nape strap are adjusted properly and the retention assembly is attached to the helmet with the screws tightened securely.
3. The visors operate properly and are clean and free of scratches and cracks.
4. All communication components have been installed properly and the earphones and microphone operate properly.
5. The overall condition of the helmet has been checked for serviceability.

**Postflight Inspections.** After each flight, the user should note any component malfunction or damage to the helmet resulting from operational use. Affected components should be replaced as specified in Table 1.

**Periodic Inspection.** Crewmembers are responsible for ensuring that their helmet assembly has been inspected, cleaned or replaced as necessary. Periodic or scheduled inspections should occur at least every 180 days or as required. Refer to Table 1 for applicable replacement procedures.

**Table 1. Periodic Inspection**

<b>COMPONENT</b>	<b>INSPECT FOR:</b>	<b>APPLICABLE PROCEDURE</b>
<b>Helmet Shell</b>	Cracks, holes, warping.  Cleanliness.	Remove all components; install components in replacement shell.  Clean per instructions on the next page.
<b>Energy-Absorbing Liner</b>	Worn or loose hook fasteners.  Gouges, cracks, indentations.	Remove liner as in Replacement Procedure 1, Page 14. Replace fasteners; reinstall liner.  Replace liner as in Replacement Procedure 1.
<b>TPL</b>	Torn or damaged areas.  Loose bond at edges.  Worn cover.	Replace TPL as in Replacement Procedure 1, Page 14.  Remove TPL as in Replacement Procedure 1; replace two sided tape attaching cloth cover to plastic layers; reinstall TPL.  Remove TPL from helmet as in Replacement Procedure 1; replace TPL cover, reinstall TPL.
<b>Earcup Assembly</b>	Cracked cup, broken or missing tab, torn earseal, worn earphone holder or spacer pad, or failed earphone.  Cleanliness.	Remove earcup as in Replacement Procedure 3, Page 16; replace parts as necessary; reinstall earcup.  Clean per instructions on the next page.
<b>Retention Assembly (including nape strap and chinstrap)</b>	Frayed or torn fabric, loose stitching, corroded or bent buckles or snap.  Cleanliness.	Replace as in Replacement Procedure 2, Page 15.  Clean per instructions on the next page.
<b>Microphone, Boom, Swivel Assembly</b>	Failed microphone; damaged or worn swivel or boom.	Replace assembly as in Replacement Procedure 4, Page 18.
<b>Microphone Cord, Connector</b>	Cuts, cracks, deteriorated insulation, general damage.	Replace as in Replacement Procedure 5, Page 19.
<b>Visor Assembly</b>	Cracks, scratches, loose knobs.  Cleanliness.	Replace as in Replacement Procedure 6, Page 21  Clean per instructions on the next page.

## CLEANING

Components of the SPH-5 helmet assembly can be cleaned as follows:

*Helmet shell and visor assembly (including visors, housing, tracks, and knobs):* Wipe with clean, soft cloth dampened with mild soap solution; rinse with clean water and allow to air dry.

*Earcups, cords, retention assembly:* Wipe with damp cloth; allow to air dry thoroughly.

*TPL cloth cover:* Machine wash (gentle cycle) or hand wash with warm water and soap; allow to air dry.

*TPL plastic layers:* Hand wash with soap and water; allow to air dry.

## REPLACEMENT PROCEDURE 1: ENERGY-ABSORBING LINER AND TPL

1. Squeezing the sides of the TPL together to clear the earcups as shown in Figure 13, remove the TPL from the helmet.
2. Remove at least one earcup from the retention assembly as in Replacement Procedure 3, Steps 1-3 (Page 16).
3. Insert a flat-tip screwdriver or a tongue depressor between the energy-absorbing liner and the helmet shell in the front and rear and disengage the hook-and-pile fasteners holding the liner in place.
4. Apply slight pressure to the energy-absorbing liner from the rear and slide it out through the front of the helmet.

### NOTE

Before you install the replacement energy-absorbing liner, ensure that its hook-fastener tabs are in place in the front and rear.

5. Install the replacement energy-absorbing liner by inserting the rear of the liner into the front of the helmet and applying slight pressure to position the liner in the helmet. Ensure that the hook-and-pile fasteners are engaged.
6. Reinstall the earcup(s) as in Replacement Procedure 3, Steps 10 -11 (Page 17).
7. Referring to **Figure 13**, squeeze the sides of the TPL together to clear the earcups and attach the TPL to the energy-absorbing liner in the helmet. Ensure that the label and holes in the plastic layers (as well as the double leg of the "Y" seam on the cloth cover) are positioned toward the front of the helmet. Center the TPL in the energy-absorbing liner. The TPL should protrude approximately 1/4" past the front edge of the energy-absorbing liner.

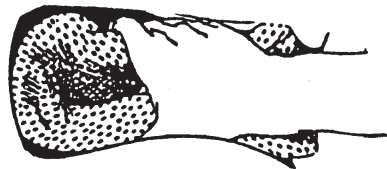

8. Recheck the helmet fit.

**Figure 13. Removing/Replacing TPL**



## REPLACEMENT PROCEDURE 2: RETENTION ASSEMBLY

1. Squeeze the sides of the TPL together and remove it from the helmet.
2. Remove the earcups from the retention assembly as in Replacement Procedure 3, Steps 1-3 (Page 16).
3. Remove the energy-absorbing liner as follows as in Replacement Procedure 1, Steps 3 and 4 (Page 14).

### NOTES

- Prior to removing attaching hardware from retention straps, note which strap holes are used for attachment. These same holes must be used when installing new retention assembly.
  - The front and center straps on both sides share attaching hardware with a helmet shell cross strap. The left rear strap shares hardware with the communications cord strain relief plate. When removing hardware from any of these points, note position and order of attachment to ensure correct installation (see **Figure 14**).
4. Remove the six screws (three each side), washers, and posts attaching the retention assembly to the helmet shell and remove the retention assembly from the helmet.

*(Continued on next page)*

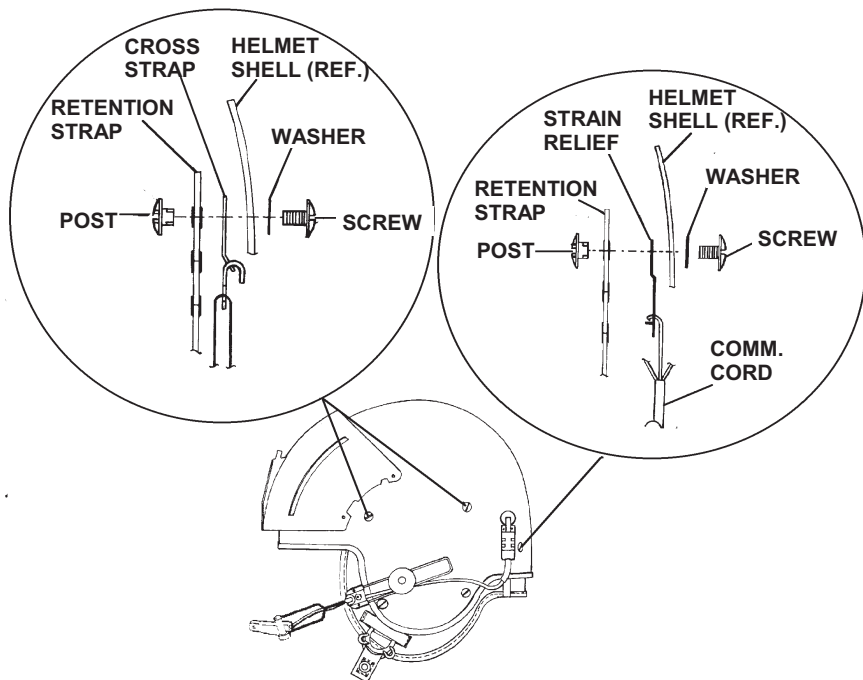

**Figure 14. Retention Assembly Attachment**

5. Align the straps of the replacement retention assembly within the helmet and install the retention assembly using hardware removed in step 3. Applying Weldwood glue #281 to the first two threads of each screw, insert the screws through holes previously used. Tighten the screws securely, but do not overtighten.
6. Reinstall the energy-absorbing liner.
7. Reinstall the TPL.
8. Reinstall the earcups as in Replacement Procedure 3, Steps 10 - 11.
9. Recheck the helmet fit.

### **REPLACEMENT PROCEDURE 3: REPLACING EARCUPS AND EARPHONES**

#### **NOTE**

Replacement of the earphone does not require earcup removal. If replacing the earphone only, perform steps 4, 5, 7, 8 and 9.

1. Pull the earcup away from the cross straps; pull retention cloth back toward the shell to expose the raised tabs on the earcup edge.
2. Insert a small, flat-tip screwdriver between the earcup and the retention assembly as shown in **Figure 15**.
3. Work the screwdriver carefully around the edge of the earcup and lift the retention cloth over the earcup tabs until the earcup is free of the cloth.

#### **NOTE**

You may rotate the earcup slightly within the retention assembly to allow room for the screwdriver between the earcup and the retention assembly.

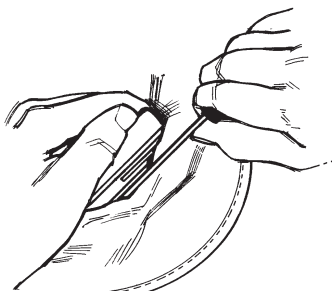

**Figure 15. Earcup Removal**

- Carefully remove the earphone holder and the earphone from the earcup.  
(See **Figure 16.**)

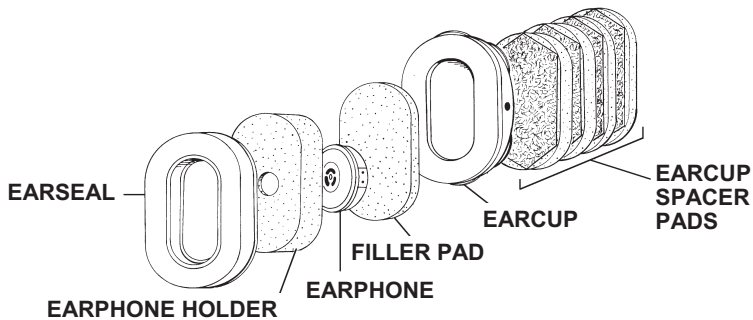

**Figure 16. Earcup Assembly**

- Remove the earphone from the earphone holder. Remove the cord leads from the earphone using a jeweler's screwdriver or a hex wrench as required.
- Remove the communications cord and the grommet from the earcup.
- Insert the communications cord and the grommet into the replacement earcup. Attach the communications cord leads to the replacement earphone using a jeweler's screwdriver or a hex key as required. Ensure filler pad is installed into earcup prior to starting the next step.
- Insert the earphone into the earphone holder, and insert both into the replacement earcup, ensuring the earphone holes are positioned toward the ear.
- Install the earseal on the earcup (if not already installed).
- Position the earcup into the retention assembly so that the retention assembly is between raised tabs on earcup.
- Carefully insert screwdriver from outside the retention assembly as shown in **Figure 17**, and lift the retention cloth over the earcup tabs.
- Repeat the procedure for the other earcup as required.
- Recheck the helmet fit.

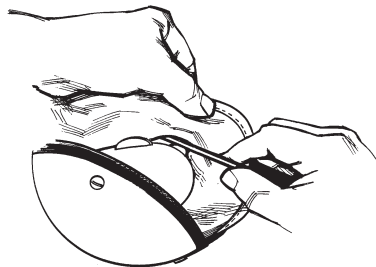

**Figure 17. Earcup Replacement**

## REPLACEMENT PROCEDURE 4: MICROPHONE ASSEMBLY

### NOTE

The microphone, microphone cord, boom, and swivel (Figure 18) are replaced as one assembly in this procedure.

1. Unplug the microphone cord from the connector at the rear of the helmet.
2. Remove the center screw attaching the boom swivel to the helmet.
3. Attach the replacement microphone, boom, and swivel assembly to the helmet with the center screw, and hand-tighten the swivel knob until secure.
4. Insert the microphone cord connector into the plug at the rear of the helmet.

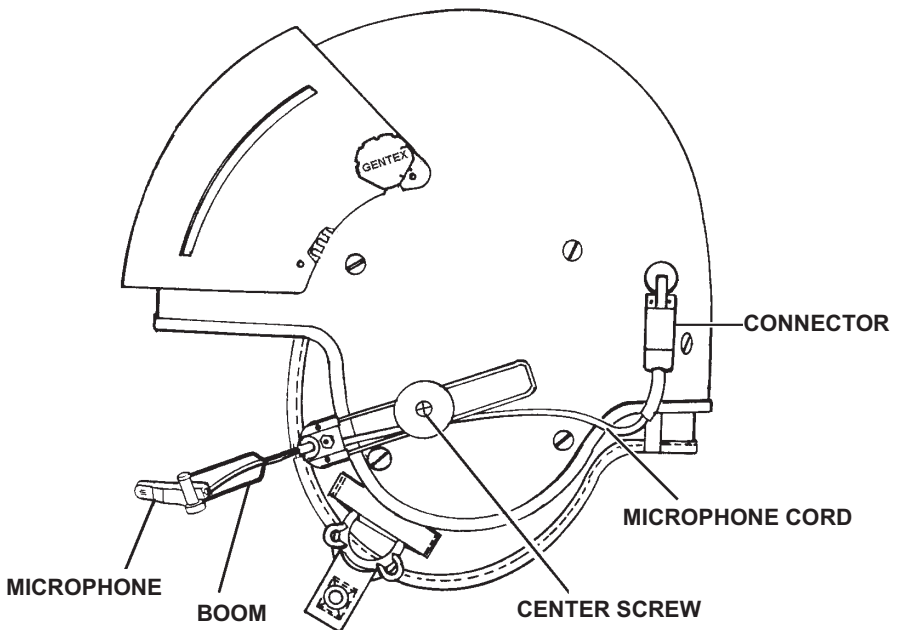

Figure 18. Microphone Assembly

## REPLACEMENT PROCEDURE 5: COMMUNICATIONS CORD

1. Unplug the microphone cord from the connector (**Figure 19**) at the rear of the helmet.
2. Cut the shrink tubing away from the connector using a razor blade or a knife.
3. Remove the connector and the two screws (**Figure 19**) securing the bracket and the mounting plate to the helmet shell.
4. Remove the TPL and slide the energy-absorbing liner out as in Replacement Procedure 1, Steps 1, 3, and 4. This will provide access to the rear retention strap and the strain relief plate.
5. Remove the screw, washer, and post securing the left rear retention strap and the cord strain relief plate from the left rear of the helmet (**Figure 19**).
6. Carefully remove the earphone holders from the earcups and the earphones from the earphone holders. Remove the cord leads from the earphones using a jeweler's screwdriver or a hex wrench as required.
7. Remove the grommet (**Figure 19**) from the helmet shell and the communications cord from the helmet.
8. Insert the replacement cord through the grommet hole in the helmet shell and attach the grommet to the helmet shell.

*(Continued on next page)*

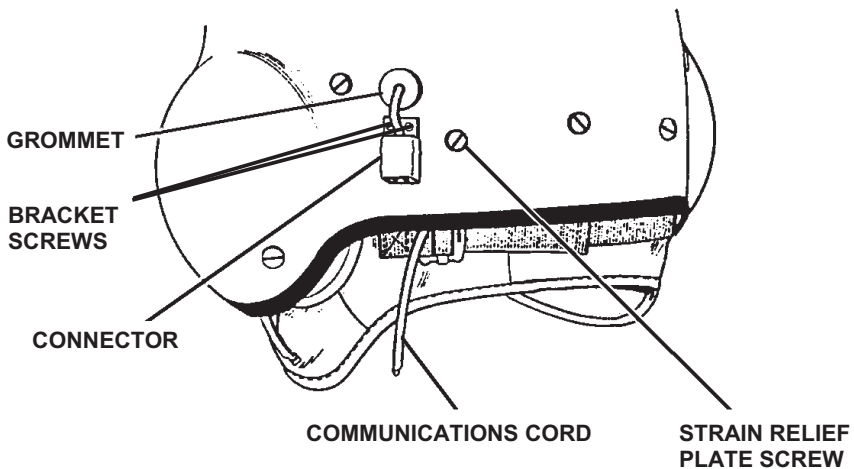

Figure 19. Communications Cord and Hardware

9. Apply Weldwood glue #281 or equivalent to the first two threads of the screw removed in Step 5. Secure the cord in the strain relief plate and attach the strain relief plate and the retention strap to the helmet shell using this screw and the associated washer and post.
10. Feed the cord through the earcups and insert the grommet into the earcup.
11. Attach the cord leads to the earphone, insert the earphone into the earphone holder, and insert both into the earcup. Ensure that the earphone holes point toward the ear.
12. Apply Weldwood glue #281 or equivalent to the first two threads of each screw removed in Step 3. Secure the connector bracket and the mounting plate to the helmet shell using these screws, and insert the connector into the bracket.
13. Install the shrink tubing on the connector as follows:
  - a. Cut a 3/4" - 1" length of shrink tubing.
  - b. Slide the tubing over the connector and the bracket.
  - c. Heat the tubing using a heat gun. Be careful not to overheat any one area.
  - d. Remove the heat as the tubing shrinks to the shape of the connector.
  - e. Carefully trim the ends of the tubing as flush as possible with the ends of the connector and the bracket using a sharp knife or small scissors.
14. Install the replacement energy-absorbing liner as in Replacement Procedure 1, Step 5 (Page 13).
15. Reinstall the TPL as in Replacement Procedure 1, Step 7.
16. Insert the microphone cord plug into the connector.
17. Recheck the helmet fit.

## REPLACEMENT PROCEDURE 6: DUAL VISOR ASSEMBLY

1. Remove the four screws (two on each side) attaching the existing visor assembly to helmet shell.

### NOTES

- Be sure to install the spacers and tracks on the side of the housing (right or left) for which they were configured. When installed correctly, these parts will curve toward the center of the visor housing (see **Figure 20**.)
- Most visor assemblies include nut plates to be installed between the posts and the underside of the helmet shell to hold the posts in place. (Visor assemblies manufactured before 1992 may not have nut plates.) Steps 5 and 6 on the next page describe the installation of the nut plate. The flat side of the nut plate (the side without the prongs) must be installed facing the visor housing. Either edge of the nut plate — the straight edge or the slotted edge — may face outward; in **Figure 20**, the straight edge is shown facing outward.
- Spacer, tracks, screws, posts, and nut plate are shown only on the left side of the visor housing in **Figure 20**. A similar configuration exists for the right side.
- Before installing screws, apply Weldwood glue #281 or equivalent to the first two threads of each screw.

*(Continued on next page)*

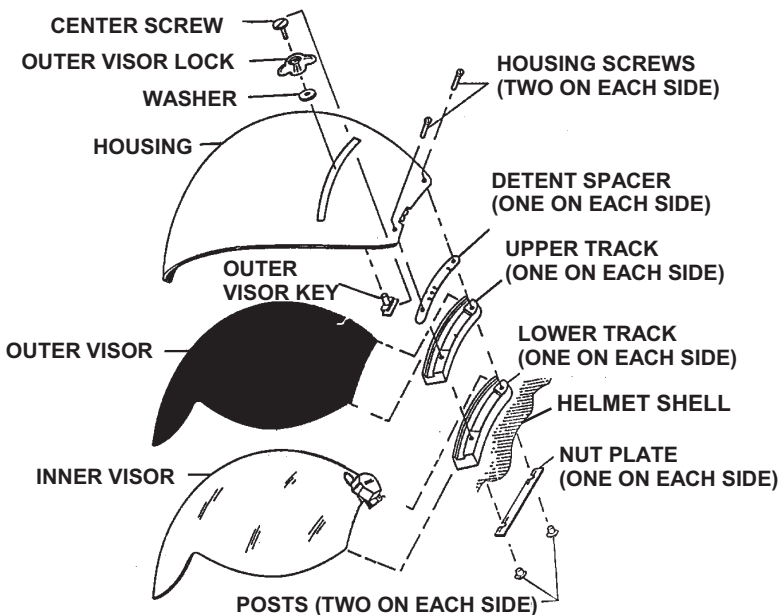

**Figure 20. Dual Visor Assembly (Exploded View)**

2. On the right side (as worn) of the visor housing, insert a replacement screw through each of the two holes. Place the right-hand detent spacer on the screws against underside of housing, followed by the right-hand upper track and the right-hand lower track in that order. Set the housing aside with the tracks and spacers facing upward so that the parts stay together.

#### **NOTE**

If nut plates are already installed, proceed to step 5. If the visor assembly does not include nut plates, it is recommended that you obtain nut plates or glue all four visor posts into the helmet shell with five-minute epoxy to prevent the posts from turning within the shell.

#### **CAUTION**

When completing step 3, ensure that 5-40 posts are used in the nut plate; other sizes will not fit and may damage the plate if forcing is attempted.

3. Bend the nut plate slightly to lift the prongs. Slide the post into the slot of nut plate so that the prongs align with the slot on the head of the post. Repeat for the other post.
4. Position the nut plate so that the flat side faces the underside of the shell. Insert the posts upward through the track holes in the shell on the right side of the helmet (as worn).
5. Holding the spacer and tracks against the housing, position them over the posts. Tighten the screws into the posts for a snug (but not tight) hold.
6. On the left side (as worn) of the visor housing, apply Weldwood glue #281 or equivalent to the first two threads of each replacement screw, and insert the screws through the holes. Lift the left side of the visor housing just enough to allow room to place the left-hand detent spacer and left-hand upper and lower tracks on screws. Holding the spacer and tracks against the housing as in the previous step, position them over the track holes on the left side of the helmet shell. Insert the posts through nut plate and through the underside of the helmet shell (on the left side as worn) as in steps 5 and 6. Tighten the screws into posts.
7. Slide the outer visor into the upper tracks. Insert the visor key through the housing slot (on either side as desired) and into the cutout in the visor; push the key down and rotate it a quarter turn counterclockwise to lock it into place. Place the washer and the visor lock over the visor key; tighten the visor lock. Install and tighten the center screw of the visor lock. (The center screw has a left-hand thread.)



8. Remove the right or left front housing screw where the inner visor knob is to be located. Use a screwdriver to lift the upper track just enough to provide clearance for the inner visor knob. Slide the inner visor into the lower tracks.
9. Realign the left (or right, as applicable) front tracks and spacer over post. Insert the screw and tighten it securely.
10. Tighten the remaining three screws securely.
11. Test the outer visor operation by using outer visor lock. Test the inner visor operation by using the inner visor knob. If either visor does not move freely, loosen the screws, hold the visor housing at the sides, and move the housing side to side as required to achieve smooth operation of both visors. Re-tighten the screws.
12. To move the outer visor lock from one side to the other, follow these steps:
  - a. Move the inner visor down about halfway.
  - b. Disassemble the outer visor lock and remove the visor key.
  - c. Move the visor key to the cutout on other side of the visor and install it as in step 9. Assemble the visor lock, washer, and center screw as in step 9. Test the visor for proper operation.
13. To move the inner visor knob from one side of the housing to the other, follow these steps:
  - a. Remove the front housing screw on the side where the visor knob is located.
  - b. Lifting the upper track slightly, slide the inner visor out of the tracks.

#### **NOTE**

Before reinstalling screws in Steps c and d, apply one or two drops of Weldwood glue #281 or equivalent to the first two threads of each screw.

- c. Remove the screws and posts attaching the knob to the visor; move the knob to the holes on the other side of the visor and reattach it with the screws and posts.
- d. Remove the front screw on other side of the housing; lift the upper track slightly and reinsert the visor into the lower track. Realign the front of the visor assembly and reinstall the front screws. Tighten the screws securely. Test the visors for proper operation.

## ILLUSTRATED PARTS BREAKDOWN

This illustrated parts breakdown lists the most common repair parts for support of the SPH-5 Helmet. The parts listed are shown in **Figure 21**. The complete helmet assembly and part numbers are available from Gentex Corporation, Carbondale, PA., U.S.A., phone (570) 282-3550, fax (570) 282-8555. If your helmet configuration differs or if you need assistance, Call Air Crew Helmet Customer Service.

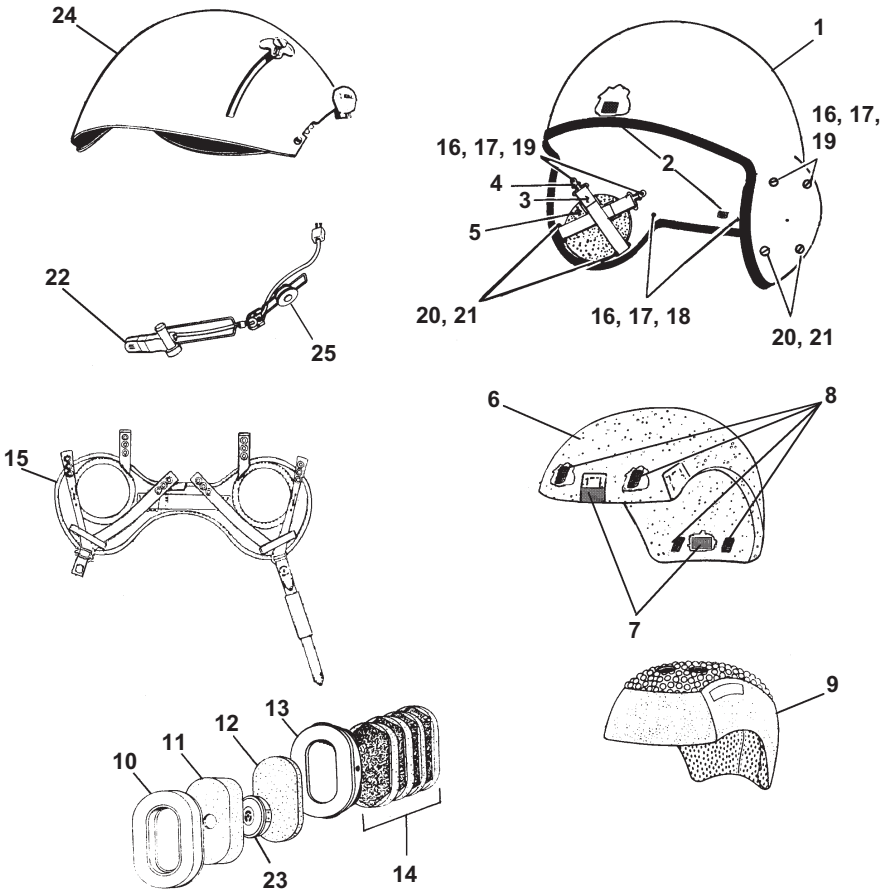

Figure 21. SPH-5 Helmet Assembly

FIG. #	DESCRIPTION	QTY.	PART #
REF.	SPH-5 Helmet Assembly, Small, Regular, X-Large, XX-Large	1	REF
1	Helmet Shell, Small, Regular	1	91D8049*
—	Helmet Shell, X-Large, XX-Large	1	91D8050*
2	Pile Fastener, ½" x 1" (Attaches to Item 7)	2	85A7256-20
3	Cross Strap, Earcup Tension	4	67B1732-1
4	Adapter	4	69A2118
5	Chafing Pad, Earcup	2	67A1777
6	Energy-Absorbing Liner, Small	1	96D8014-1
—	Energy-Absorbing Liner, Regular	1	85D7286-2
—	Energy-Absorbing Liner, X-Large	1	85D7211-2
—	Energy-Absorbing Liner, XX-Large	1	91D8203-1
7	Hook Fastener (Attaches to Item 2)	2	90B8021-2
8	Hook Fastener (Attaches to Item 9)	4	85B7027
9	TPL, Small	1	85D7087-31
—	TPL, Regular	1	85D7087-4
—	TPL, X-Large, XX-Large	1	85D7087-5
10	Earpad Seal	2	88C7589
11	Cushion, Earcup Insert	2	83C6573
12	Filler Pad	2	81B6572-5
13	Earcup, Right	1	85C7135-4
—	Earcup, Left (Not Shown)	1	85C7135-5
14	Spacer Pad Kit	1	71B2302
15	Retention Assembly, OD	1	90D8018-1
—	Retention Assembly, Black	1	90D8018-2
16	Washer, Spring	10	76A3443
17	Screw, 8-32 x 1/4"(Retention)	6	75A3093-9
18	Post, 1/8" (Rear retention)	1	69A2104-2
19	Post, 3/16" (Front retention)	5	69A2104-3
20	Screw, 8-32 x 3/16, Black (Cross Strap, Bottom)	4	75A3093-5
21	Post, 1/16 (Cross Strap, Bottom)	4	69A2104-1
—	Cord, Coiled, Wired in parallel (Not Shown)	1	87B7491-2**
22	Microphone & Boom Assy (with Mic cord)	1	78B4161-2**
23	Earphones, 1000-ohm	2	71B2383**
24	Lt. weight Dual Visor Assy, Plain, Outer & Inner Visor	1	91B8069*
25	Swivel Assy - Boom Support	1	67A1763
—	Instruction Book	1	TP0047

\*Optional colors/visor configurations available. Contact Gentex aircrew helmet customer service for specifics. \*\*Optional communications equipment also available.

### OTHER VISOR STYLES AVAILABLE

Other SPH helmets are available in a variety of visor styles as shown in **Figure 23**:

- SPH-5 with single visor assembly
- SPH-5 with direct-mount ANVIS dual visor assembly
- SPH-5 with quick-disconnect ANVIS dual visor assembly

Contact GENTEX Corporation for more information.

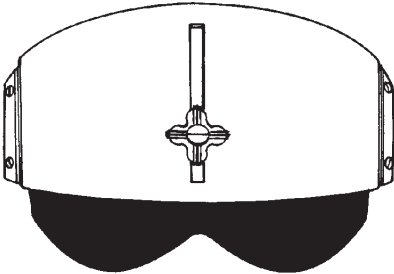

**SINGLE VISOR ASSEMBLY**

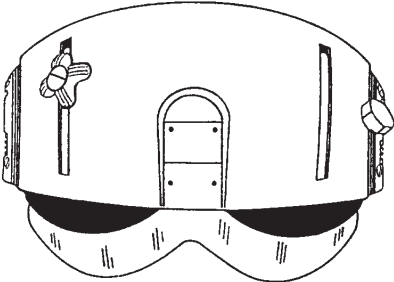

**ANVIS DIRECT MOUNT  
DUAL VISOR ASSEMBLY**

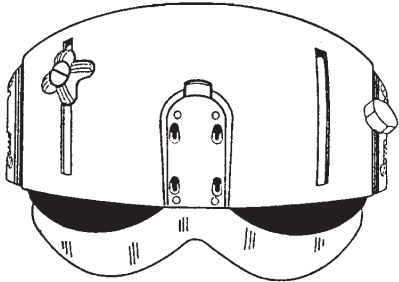

**ANVIS QUICK-DISCONNECT  
DUAL VISOR ASSEMBLY**

**Figure 23. SPH-5 Visor Kits**

## NOTES





**GENTEX<sup>®</sup>**  
CORPORATION

[www.gentexcorp.com](http://www.gentexcorp.com)

PO BOX 315 CARBONDALE, PENNSYLVANIA 18407 USA  
p 570 282 3550 f 570 282 8555 [sales@gentexcorp.com](mailto:sales@gentexcorp.com)